

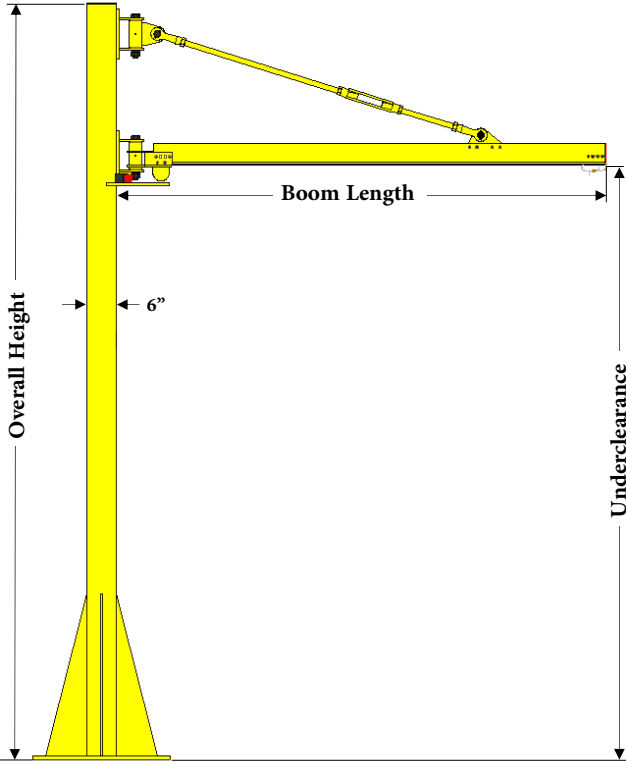

## ETA-4 Jib Cranes

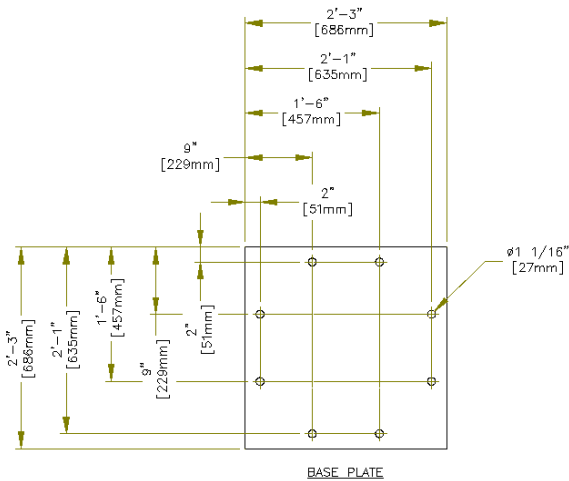

Part #	Boom Length	Underclearance	Overall Height	Rated Load
98760	6'-0"	10'-0"	12'-8"	650 LBS.
98761	6'-0"	12'-0"	14'-8"	650 LBS.
98762	7'-0"	10'-0"	12'-8"	600 LBS.
98763	7'-0"	12'-0"	14'-8"	600 LBS.
98764	8'-0"	10'-0"	12'-8"	500 LBS.
98765	8'-0"	12'-0"	14'-8"	500 LBS.
98766	9'-0"	10'-0"	13'-2"	450 LBS.
98767	9'-0"	12'-0"	15'-2"	450 LBS.
98768	10'-0"	10'-0"	13'-2"	400 LBS.
98769	10'-0"	12'-0"	15'-2"	400 LBS.
98770	11'-0"	10'-0"	13'-2"	350 LBS.
98771	11'-0"	12'-0"	15'-2"	350 LBS.
98772	12'-0"	10'-0"	13'-8"	300 LBS.
98773	12'-0"	12'-0"	15'-8"	300 LBS.
98774	13'-0"	10'-0"	13'-8"	300 LBS.
98775	13'-0"	12'-0"	15'-8"	300 LBS.
98776	14'-0"	10'-0"	13'-8"	275 LBS.
98777	14'-0"	12'-0"	15'-8"	275 LBS.
98778	15'-0"	10'-0"	14'-2"	250 LBS.
98779	15'-0"	12'-0"	16'-2"	250 LBS.
98780	16'-0"	10'-0"	14'-2"	200 LBS.
98781	16'-0"	12'-0"	16'-2"	200 LBS.
98782	17'-0"	10'-0"	14'-2"	175 LBS.
98783	17'-0"	12'-0"	16'-2"	175 LBS.
98784	18'-0"	10'-0"	14'-8"	150 LBS.
98785	18'-0"	12'-0"	16'-8"	150 LBS.
98786	19'-0"	10'-0"	14'-8"	150 LBS.
98787	19'-0"	12'-0"	16'-8"	150 LBS.
98788	20'-0"	10'-0"	14'-8"	125 LBS.
98789	20'-0"	12'-0"	16'-8"	125 LBS.



Part #	Description
98535	6" Jib Column Welded Index Stop Assembly for ETA-4
98536	6" Jib Column Bolted Index Stop Assembly for ETA-4

**Test Load:** Shall not be more than 125% of the Rated Load unless recommended by the manufacturer. Column shall not be loaded beyond it's rated load capacity except for test purposes.

**Notes:**

1. Consult Factory for underclearances more than 12'-0"
2. The minimum anchor requirement is a 3/4" wedge type anchor bolt with 3-1/4" standard embedment in 6" 3000 PSI concrete.
3. Rated Load is based on 1/450 Deflection.
4. Rated Loads above 550 lbs. require a dual hoist trolley.

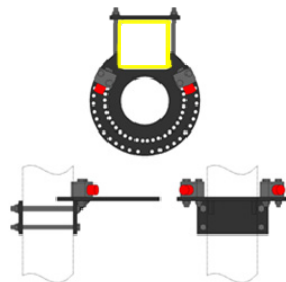
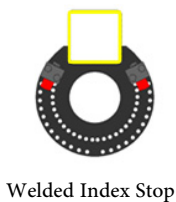



**ETA-4 Wall-Mount Jib Cranes**

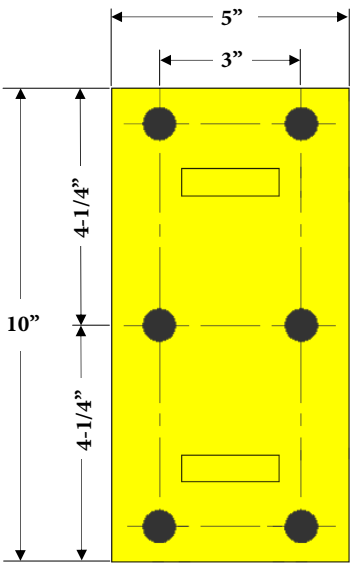
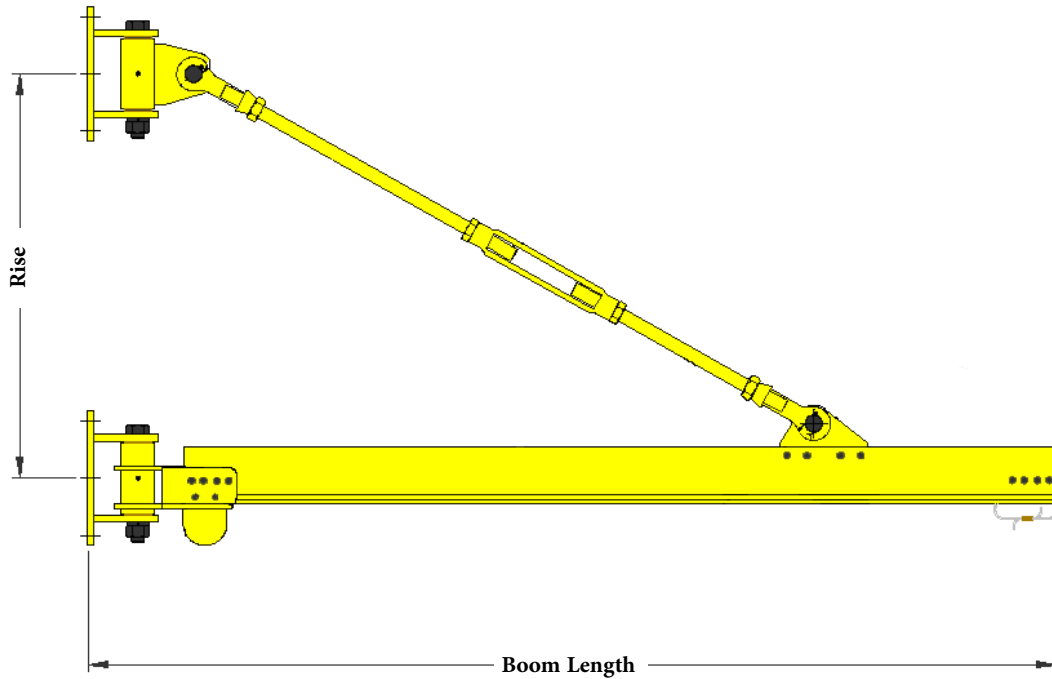

**Mounting Plate**

Part #	Boom Length	Rise	Rated Load
98806	6'-0"	2'-0"	650 LBS.
98807	7'-0"	2'-0"	600 LBS.
98808	8'-0"	2'-0"	500 LBS.
98809	9'-0"	2'-6"	450 LBS.
98810	10'-0"	2'-6"	400 LBS.
98811	11'-0"	2'-6"	350 LBS.
98812	12'-0"	3'-0"	300 LBS.
98813	13'-0"	3'-0"	300 LBS.
98814	14'-0"	3'-0"	275 LBS.
98815	15'-0"	3'-6"	250 LBS.
98816	16'-0"	3'-6"	200 LBS.
98817	17'-0"	3'-6"	175 LBS.
98818	18'-0"	4'-0"	150 LBS.
98819	19'-0"	4'-0"	150 LBS.
98820	20'-0"	4'-0"	125 LBS.

Part #	Description
98536	6" Jib Column Bolted Index Stop Assembly for ETA-4

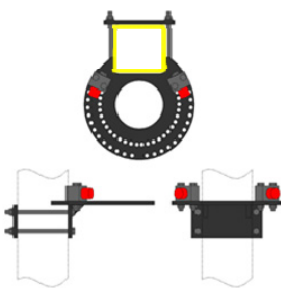

**Bolt-on Index Stop**

**Test Load:** Shall not be more than 125% of the Rated Load unless recommended by the manufacturer.  
 Rated Load is based on 1/450 Deflection.





**ETA-5 Wall-Mount Jib Cranes**

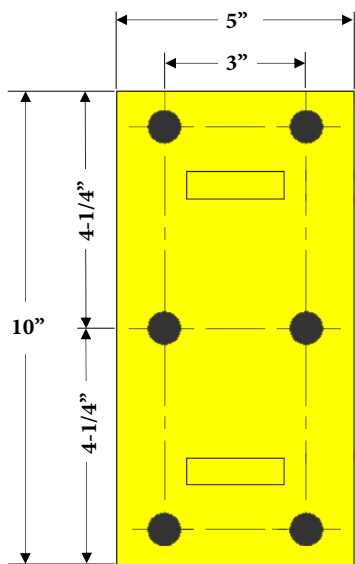
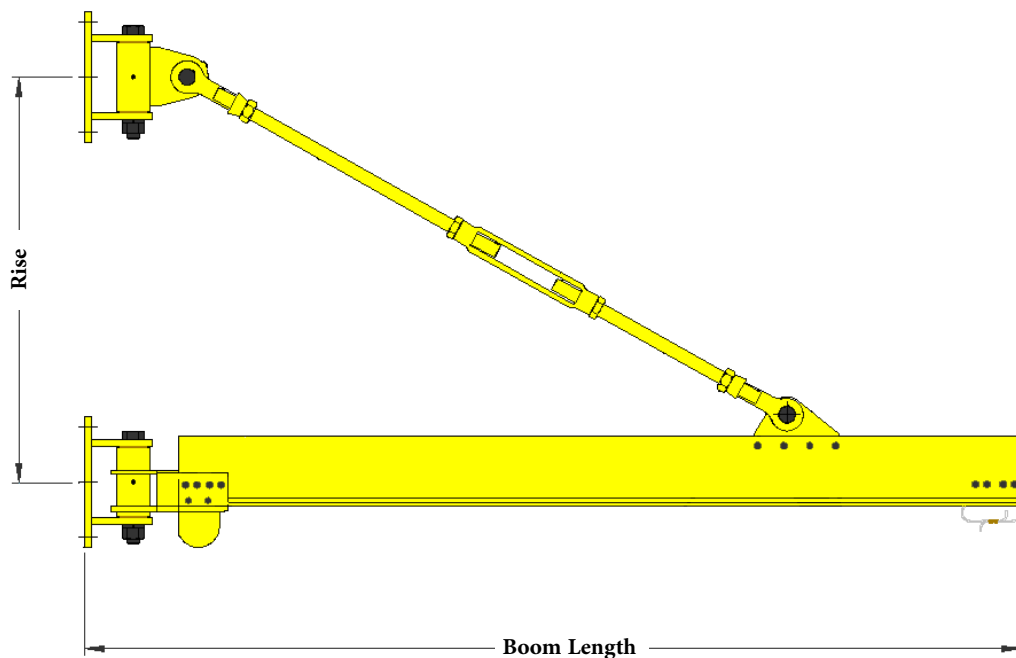

**Mounting Plate**

Part #	Boom Length	Rise	Rated Load
98606	6'-0"	2'-0"	1100 LBS.
98607	7'-0"	2'-0"	1100 LBS.
98608	8'-0"	2'-0"	1100 LBS.
98609	9'-0"	2'-6"	1000 LBS.
98610	10'-0"	2'-6"	900 LBS.
98611	11'-0"	2'-6"	900 LBS.
98612	12'-0"	3'-0"	700 LBS.
98613	13'-0"	3'-0"	600 LBS.
98614	14'-0"	3'-0"	500 LBS.
98615	15'-0"	3'-6"	500 LBS.
98616	16'-0"	3'-6"	400 LBS.
98617	17'-0"	3'-6"	350 LBS.
98618	18'-0"	4'-0"	300 LBS.
98619	19'-0"	4'-0"	250 LBS.
98620	20'-0"	4'-0"	200 LBS.

Part #	Description
98541	8" Jib Column Bolted Index Stop Assembly for ETA-5

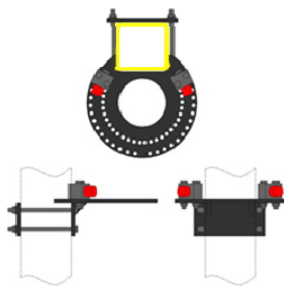

**Bolt-on Index Stop**

**Test Load:** Shall not be more than 125% of the Rated Load unless recommended by the manufacturer.  
 Rated Load is based on 1/450 Deflection.



## ETA-8 Jib Cranes

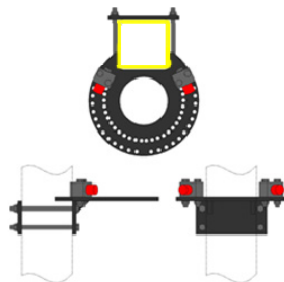
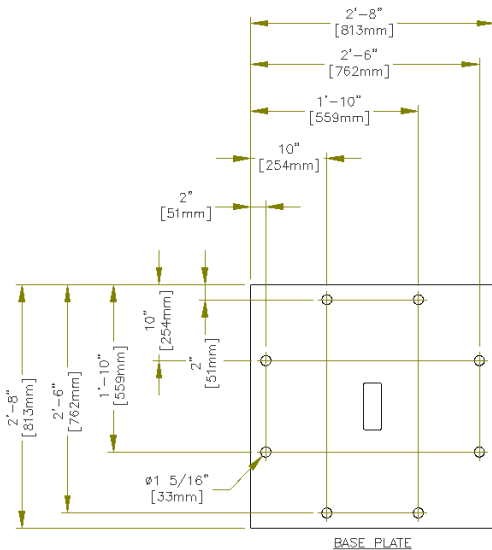
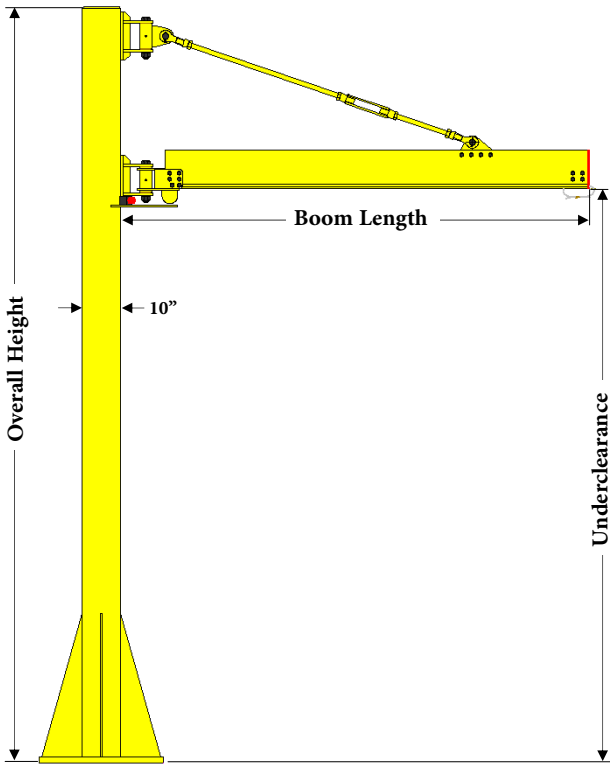

Part #	Boom Length	Underclearance	Overall Height	Rated Load
98561	6'-0"	10'-0"	12'-8"	2100 LBS.
98562	6'-0"	12'-0"	14'-8"	2100 LBS.
98563	7'-0"	10'-0"	12'-8"	2000 LBS.
98564	7'-0"	12'-0"	14'-8"	2000 LBS.
98566	8'-0"	10'-0"	12'-8"	1800 LBS.
98567	8'-0"	12'-0"	14'-8"	1800 LBS.
98568	9'-0"	10'-0"	13'-2"	1700 LBS.
98569	9'-0"	12'-0"	15'-2"	1700 LBS.
98570	10'-0"	10'-0"	13'-2"	1500 LBS.
98571	10'-0"	12'-0"	15'-2"	1500 LBS.
98572	11'-0"	10'-0"	14'-0"	1500 LBS.
98573	11'-0"	12'-0"	16'-0"	1500 LBS.
98574	12'-0"	10'-0"	14'-0"	1500 LBS.
98575	12'-0"	12'-0"	16'-0"	1500 LBS.
98576	13'-0"	10'-0"	14'-8"	1400 LBS.
98577	13'-0"	12'-0"	16'-8"	1400 LBS.
98578	14'-0"	10'-0"	14'-8"	1300 LBS.
98579	14'-0"	12'-0"	16'-8"	1300 LBS.
98580	15'-0"	10'-0"	15'-4"	1200 LBS.
98581	15'-0"	12'-0"	17'-4"	1200 LBS.
98582	16'-0"	10'-0"	15'-4"	1200 LBS.
98583	16'-0"	12'-0"	17'-4"	1200 LBS.
98584	17'-0"	10'-0"	16'-0"	1000 LBS.
98585	17'-0"	12'-0"	18'-0"	1000 LBS.
98586	18'-0"	10'-0"	16'-0"	1000 LBS.
98587	18'-0"	12'-0"	18'-0"	1000 LBS.
98588	19'-0"	10'-0"	16'-8"	900 LBS.
98589	19'-0"	12'-0"	18'-8"	900 LBS.
98590	20'-0"	10'-0"	16'-8"	850 LBS.
98591	20'-0"	12'-0"	18'-8"	850 LBS.

Part #	Description
98545	10" Jib Column Welded Index Stop Assembly for ETA-8
98546	10" Jib Column Bolted Index Stop Assembly for ETA-8

**Test Load:** Shall not be more than 125% of the Rated Load unless recommended by the manufacturer. Column shall not be loaded beyond it's rated load capacity except for test purposes.

**Notes:**

1. Consult Factory for underclearances more than 12'-0
2. The minimum anchor requirement is a 1" wedge type anchor bolt with 6" standard embedment in 9" 3000 PSI concrete.
3. Rated Load is based on 1/450 Deflection.
4. Rated Loads above 1100 lbs. require a dual hoist trolley.



**ETA-8 Wall-Mount Jib Cranes**

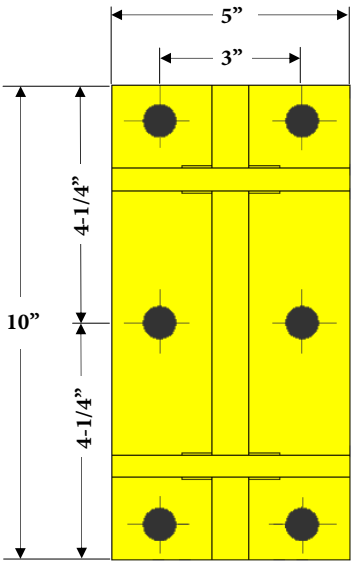
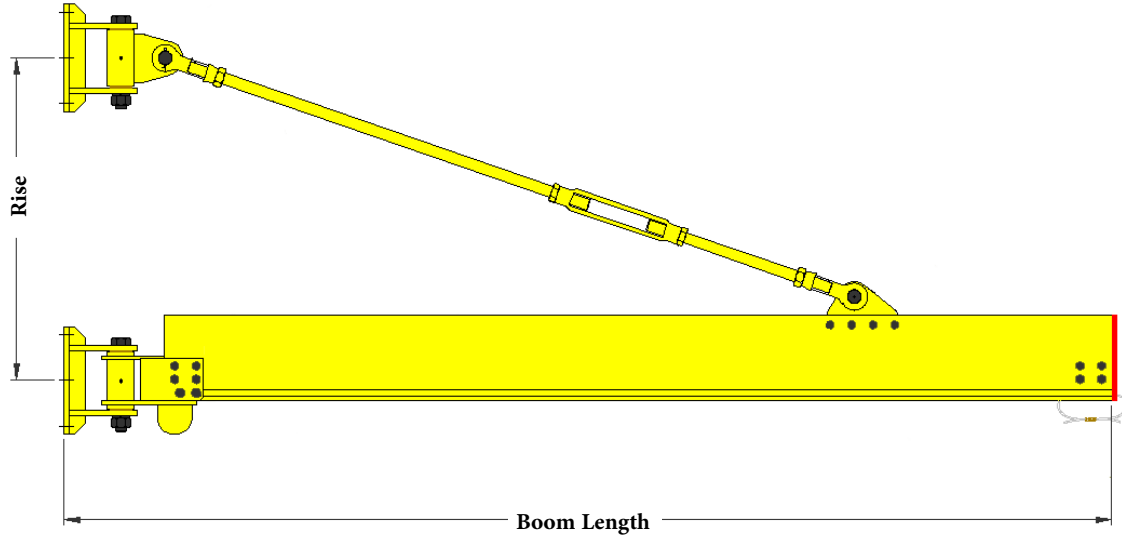

**Mounting Plate**

Part #	Boom Length	Rise	Rated Load
98490	6'-0"	2'-0"	2100 LBS.
98495	7'-0"	2'-0"	2100 LBS.
98500	8'-0"	2'-0"	1800 LBS.
98503	9'-0"	2'-6"	1700 LBS.
98505	10'-0"	2'-6"	1500 LBS.
98508	11'-0"	3'-4"	1500 LBS.
98510	12'-0"	3'-4"	1500 LBS.
98513	13'-0"	4'-0"	1400 LBS.
98515	14'-0"	4'-0"	1300 LBS.
98518	15'-0"	4'-8"	1200 LBS.
98520	16'-0"	4'-8"	1200 LBS.
98523	17'-0"	5'-4"	1000 LBS.
98525	18'-0"	5'-4"	1000 LBS.
98528	19'-0"	6'-0"	900 LBS.
98530	20'-0"	6'-0"	850 LBS.

Part #	Description
98546	10" Jib Column Bolted Index Stop Assembly for ETA-8

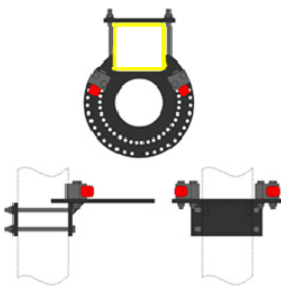

**Bolt-on Index Stop**

**Test Load:** Shall not be more than 125% of the Rated Load unless recommended by the manufacturer.  
 Rated Load is based on 1/450 Deflection.

