

Will move onto a wider world.

Dong Bo, a leading company with unchanged will and continuous effort, has grown solidly for the past 40 years with the aim to become the best. Now, aimed with know-how and fame, Dong Bo will make a global expansion towards 50th Anniversary. Dong Bo will create a business culture of the 21st century.

NOS Chain

No need of oil supply

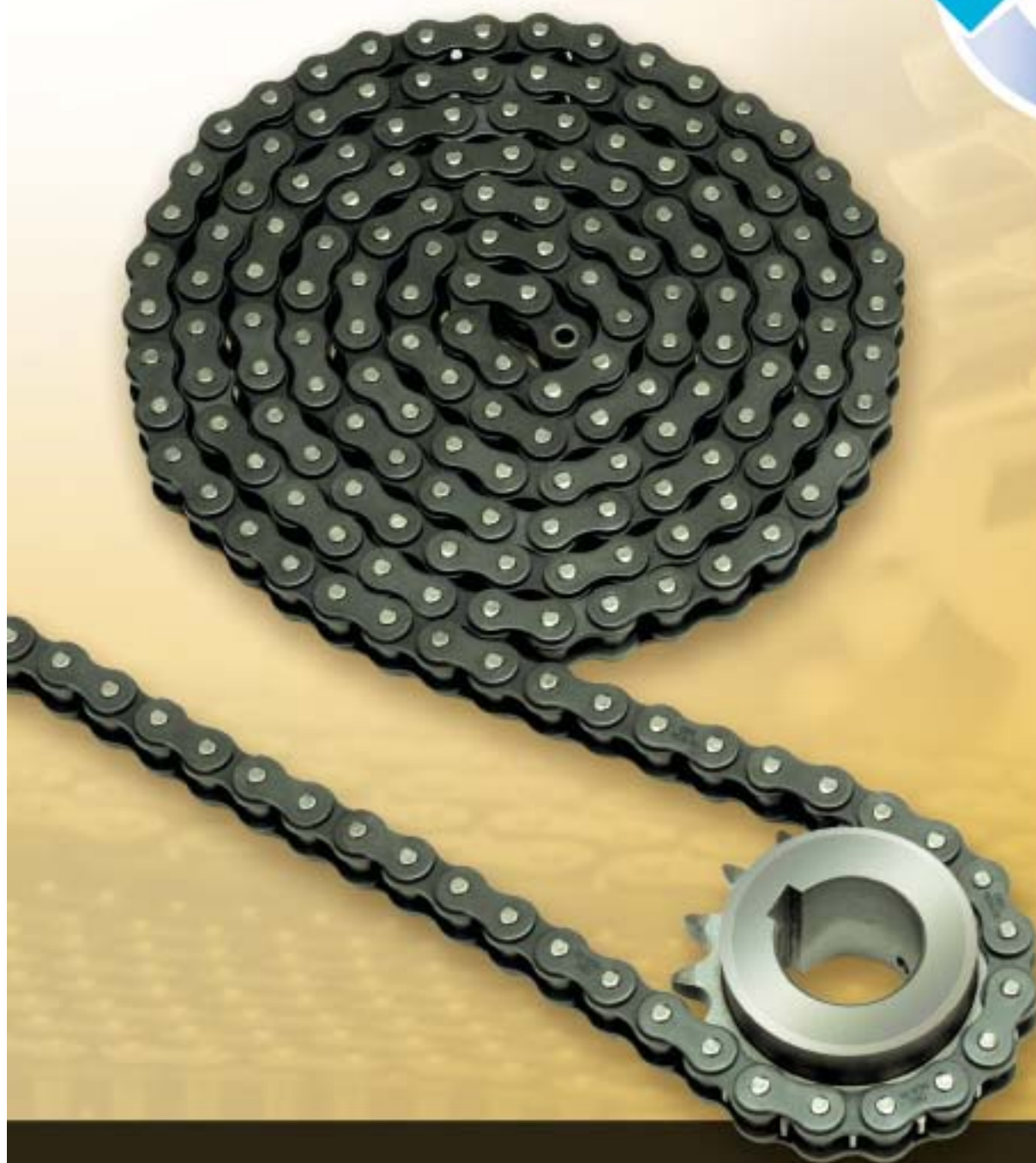

DONG BO CHAIN IND.CO.,LTD.

Dong Bo NOS chain adopted oil-contained sintered bushing which made considerable improvement of durability through self-lubricating ability with no need of additional lubrication. Choice of NOS chain can be optimum to the environment of limited or inapplicable lubrication.

ECONOMIC CHAIN

- Extended life by 40 times at low speed of 30M/min and by 10 times at normal 90M/min comparing to standard roller chain.
- As extended life saves costs for frequent changes of chains, NOS is considered as the most economic and effective chain in this point.



ENVIRONMENTALLY FRIENDLY CHAIN

- Thanks to no needs of lubrication surroundings are prevented from being polluted by lubricant, and low noise also contributes to better working environment.
- Improved anti-corrosion by special coating on surface of the chain

COMPATIBLE CHAIN

- Identical design to standard roller chain, with same dimensions and same specifications: no need to change related equipments.

동보 NOS Chain은 오일을 함유한 특수 부쉬를 적용하여 추가적인 급유 없이 자체윤활 기능을 통해 내구성을 현저히 향상시킨 제품이며, 특히 사용 특성상 급유를 할수 없거나, 제한적인 급유만이 가능한 경우 선택할 수 있는 최적의 체인입니다.

경제적인 체인

- 표준형 롤러체인 대비 저속(30M/min) 사용시 40배, 일반속도(90M/min)내 사용시 최소 10배로 사용수명이 신장되었습니다.
- 사용수명의 연장으로 잦은 체인 교체시의 비용을 절감하여, 비용 대비 효과가 큰 경제적인 제품입니다.

환경친화적인 체인

- 추가 급유가 필요 없으므로, 오일로 인한 오염이 미연에 방지되어 청결 유지 및 저소음 사용이 가능하여 주변 환경의 개선이 가능합니다.
- 체인 표면의 특수 코팅처리로 인해 내식성까지 향상된 제품입니다.

호환성이 풍부한 체인

- 표준형 롤러체인과 동일한 치수 및 파단강도를 지니도록 제작되어 기존 설비의 변경없이 적용이 가능합니다.

CONSTRUCTION

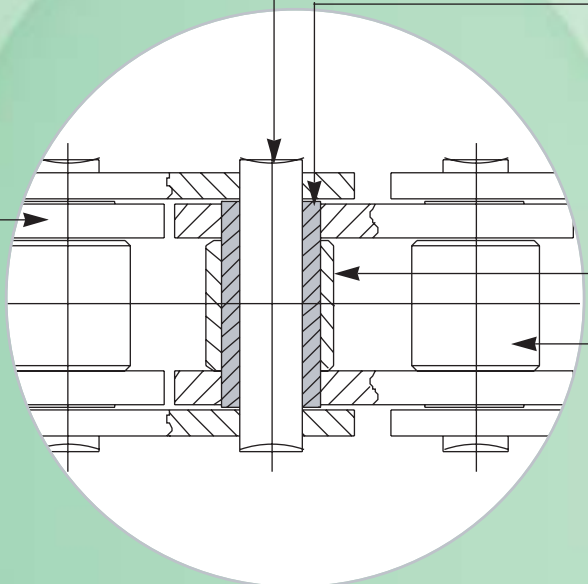

DIMENSIONS

1열 : Single strand

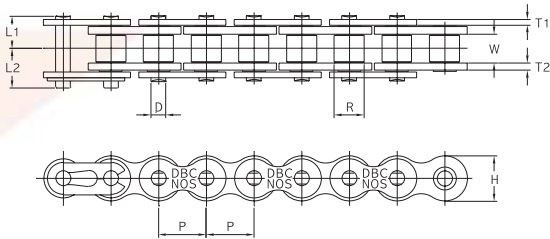

2열 : Double strand

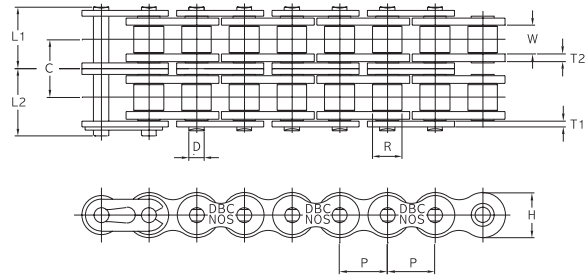

unit : mm

DONG BO Chain NO.	Pitch P	Inner Width W	Roller Dia R	Plate				Pin			Average Breaking Load Kgf	Max. Allowable Load Kgf	Approx. Weight Kg/m	Allowable Speed m/min
				T1	T2	H	h	D	L1	L2				
DBC NOS 40	12.7	7.55	7.94	1.5	2	12	10.4	3.97	8.7	10.4	1,950	370	0.70	150
DBC NOS 50	15.875	9.26	10.16	2	2.4	15	13	5.09	10.56	12.56	3,200	650	1.11	135
DBC NOS 60	19.05	12.28	11.86	2.4	3.2	18.1	15.6	5.96	13.6	15.1	4,500	900	1.72	120
DBC NOS 40-2	12.7	7.55	7.94	1.5	2	12	10.4	3.97	16.45	17.95	3,900	518	1.40	150
DBC NOS 50-2	15.875	9.26	10.16	2	2.4	15	13	5.09	20.15	22.15	6,400	910	2.20	135
DBC NOS 60-2	19.05	12.28	11.86	2.4	3.2	18.1	15.6	5.96	25.9	27.4	9,000	1,260	3.40	120

*Contact us for SPECIFICATIONS & DIMENSIONS of BS / Double pitch chain (상기 규격외 BS / Bi-pitch Type은 별도 문의 바랍니다.)

RESULT OF WEAR TEST

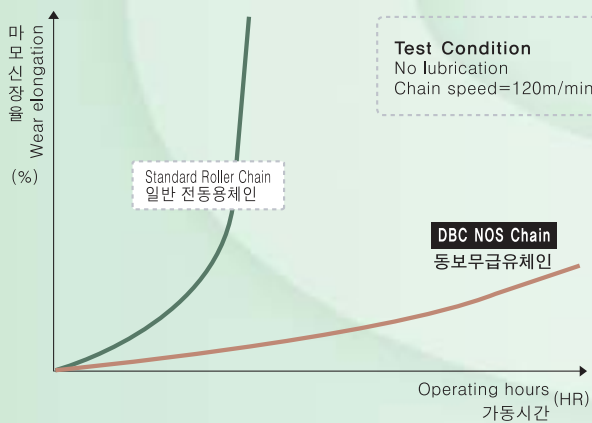

Main Usages

- Electronic / Electricity / Automobile industry
- Medicine manufacturing line
- Food processing / Packing industry
- Printing industry
- Textile industry
- Paper / Publication industry
- Glass / China industry
- Any of lubrication limited or unavailable environment in conveying line

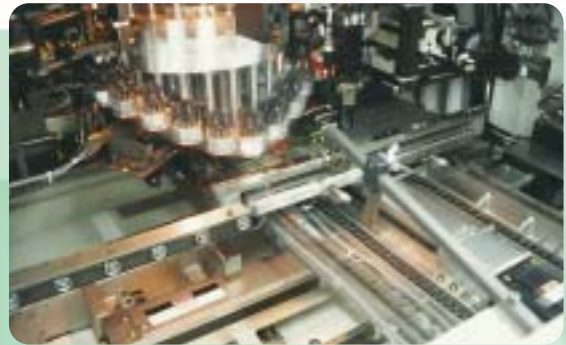
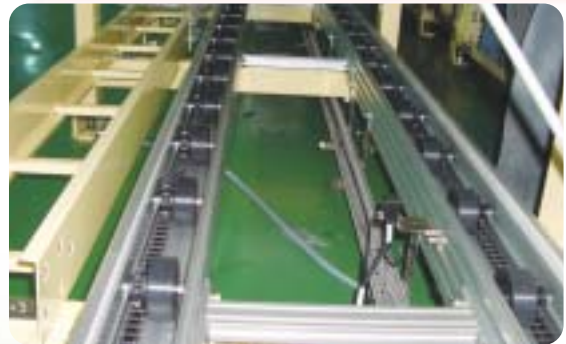

- 전자, 전기, 자동차 산업
- 의약품 제조라인
- 식품 가공 및포장산업
- 인쇄 분야
- 섬유 산업
- 제지 및출판산업
- 유리 및도기산업
- 이외 체인 사용시 급유가 제한적이거나 불가능한 컨베이어 라인

Applicable Products

▶ Small Pitch Conveyor Chain



▶ Large Pitch Conveyor Chain



▶ Roller Chain

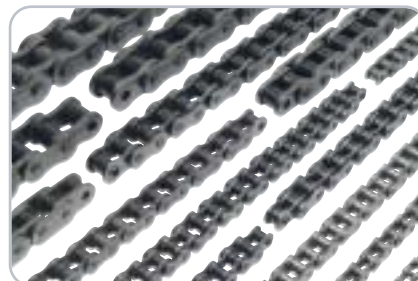

▶ Leaf Chain



▶ Free Flow Chain

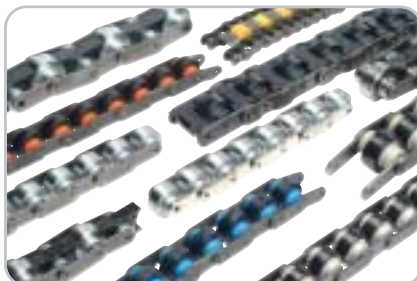

▶ Specialty Chain

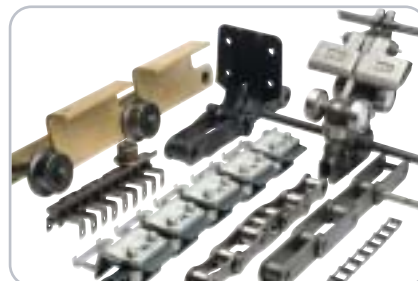

▶ Environment Resistant Chain



▶ Parts



▶ Sprocket



Website : www.dongbochain.com
E-mail : dbc@dongbochain.com

Head Office & Factory

940-20, YELIM-LI, CHUNGGWAN-MYUN, KIJANG-GUN, BUSAN, SOUTH KOREA
TEL : +82-51-727-6911/6 (6 lines) FAX : +82-51-727-6917

Seoul Office

MICRO BUILDING A-103, 554-2, GASAN-DONG, GEUMCHEON-GU, SEOUL, SOUTH KOREA
TEL : +82-2-839-9102 FAX : +82-2-865-4973

China Factory

218, CH UNCH ENG ROAD, CH ENGYANG WARD, QINGDAO, P.R OF CH INA
TEL : +86-532-8796-3341~4 (4 lines) FAX : +86-532-8796-3346



東寶利工業株式會社
DONG BO CHAIN INDUSTRY CO.,LTD.